



**ETP4830-A1
V300R001
User Manual**

Issue **09**
Date **2016-01-28**

Copyright © Huawei Technologies Co., Ltd. 2016. All rights reserved.

No part of this document may be reproduced or transmitted in any form or by any means without prior written consent of Huawei Technologies Co., Ltd.

Trademarks and Permissions



and other Huawei trademarks are trademarks of Huawei Technologies Co., Ltd.

All other trademarks and trade names mentioned in this document are the property of their respective holders.

Notice

The purchased products, services and features are stipulated by the contract made between Huawei and the customer. All or part of the products, services and features described in this document may not be within the purchase scope or the usage scope. Unless otherwise specified in the contract, all statements, information, and recommendations in this document are provided "AS IS" without warranties, guarantees or representations of any kind, either express or implied.

The information in this document is subject to change without notice. Every effort has been made in the preparation of this document to ensure accuracy of the contents, but all statements, information, and recommendations in this document do not constitute a warranty of any kind, express or implied.

Huawei Technologies Co., Ltd.

Address: Huawei Industrial Base
Bantian, Longgang
Shenzhen 518129
People's Republic of China

Website: <http://e.huawei.com>

About This Document

Purpose

This document describes the DC power system in terms of product overview, components, installation, commissioning, and maintenance. This document also describes operations for the site monitoring unit (SMU) and rectifiers.

The figures provided in this document are for reference only.





Intended Audience

This document is intended for:

- Sales specialist
- Technical support personnel
- Maintenance personnel

Symbol Conventions

The symbols that may be found in this document are defined as follows.

Symbol	Description
 DANGER	Indicates an imminently hazardous situation which, if not avoided, will result in death or serious injury.
 WARNING	Indicates a potentially hazardous situation which, if not avoided, could result in death or serious injury.
 CAUTION	Indicates a potentially hazardous situation which, if not avoided, may result in minor or moderate injury.
 NOTICE	Indicates a potentially hazardous situation which, if not avoided, could result in equipment damage, data loss, performance deterioration, or unanticipated results. NOTICE is used to address practices not related to personal injury.
 NOTE	Calls attention to important information, best practices and tips. NOTE is used to address information not related to personal injury, equipment damage, and environment deterioration.

Change History

Changes between document issues are cumulative. The latest document issue contains all the changes made in earlier issues.

Issue 09 (2016-01-28)

Chapter 4 Installation

Added section "[Connecting the Dual-Live of IT 230V Net or TN 208V Net AC Input Power Cable](#)".

Issue 08 (2014-10-30)

Chapter 6 Commissioning

Added section "[6.5 Setting Battery Parameters](#)".

Issue 07 (2014-07-18)

Chapter 6 Commissioning

Modified "[6.5 Setting Battery Parameters](#)".

Added section "[6.6 \(Optional\) Setting DC Parameters](#)".

Issue 06 (2014-02-20)

Chapter 4 Installation

Added section "[4.3.2 \(Optional\) Installing Dry Contact Signal Cables](#)".

Modified "[Figure 4-5 Connecting the ground cable](#)".

Modified "[Figure 4-11 Connecting the single-phase AC input power cable](#)".

Chapter 6 Commissioning

Added section "[6.4 Setting System Type](#)".

Issue 05 (2013-07-02)

Add the configuration of R4815G1, SMU01A and SMU01C.

Issue 04 (2013-05-07)

Optimized the content of the document, including standardizing the terminology and improving the accuracy of the description

Issue 03 (2013-04-18)

Modify operating temperature, input voltage and output voltage.

Issue 02 (2012-12-03)

Port description is modified.

Issue 01 (2012-05-11)

This issue is the first official release.

Contents

About This Document	ii
1 Safety Precautions	1
1.1 General Safety	1
1.2 Electrical Safety	2
1.3 Battery Safety	3
1.4 Cable Layout.....	4
1.5 Mechanical Safety	4
2 Overview	6
2.1 Introduction	6
2.2 Model Number Description	6
2.3 Features.....	6
2.4 Configuration.....	7
3 Components	9
3.1 AC/DC Power Distribution Subrack	9
3.2 Rectifier	9
3.3 SMU	11
3.3.1 SMU01A.....	11
3.3.2 SMU01B.....	14
3.3.3 SMU01C.....	16
4 Installation	20
4.1 Installing a Subrack	20
4.2 Installing Components	21
4.2.1 Installing an SMU	21
4.2.2 Installing a Rectifier	22
4.3 Connecting Cables	22
4.3.1 Connecting the Ground Cable.....	22
4.3.2 (Optional) Installing Dry Contact Signal Cables	23
4.3.3 Connecting the Communications Cable.....	23
4.3.4 Connecting the DC Load Cable	25
4.3.5 Connecting the Battery Cable	26
4.3.6 Connecting the AC Input Power Cable	26

5 Verifying the Installation	28
5.1 Checking Hardware Installation	28
5.2 Checking Electrical Connections	28
5.3 Checking Cable Installation.....	28
6 Commissioning	29
6.1 Connecting the AC Power Supply	29
6.2 Setting the Display Language	30
6.3 Setting Time and Date	30
6.3.1 SMU01A.....	30
6.3.2 SMU01B and SMU01C	30
6.4 Setting System Type	31
6.5 Setting Battery Parameters.....	31
6.5.1 SMU01A.....	31
6.5.2 SMU01B and SMU01C	31
6.6 (Optional) Setting DC Parameters	32
6.7 (Optional) Setting Hibernation Parameters.....	32
6.7.1 SMU01A.....	32
6.7.2 SMU01B and SMU01C	33
6.8 (Optional) Setting Alarm Parameters	33
6.8.1 SMU01A.....	33
6.8.2 SMU01B and SMU01C	34
6.9 (Optional) Setting Communications Parameters.....	35
6.9.1 SMU01A.....	35
6.10 Connecting the Battery Supply	39
7 Maintenance	41
7.1 Routine Maintenance	41
7.2 Rectifying Common Faults	42
7.2.1 Mains Failure	42
7.2.2 AC Over Volt	42
7.2.3 AC Under Volt	42
7.2.4 DC Over Volt	42
7.2.5 DC Under Volt	43
7.2.6 Amb. Over Temp.....	43
7.2.7 Amb. Under Temp.....	44
7.2.8 Batt Over Temp.....	44
7.2.9 Batt Under Temp.....	44
7.2.10 Batt Chg. Overcur.	45
7.2.11 Load Fuse Break	45
7.2.12 Batt Loop Trip.....	45
7.2.13 Batt Off	46
7.2.14 Door Alarm	46

7.2.15 Water Alarm	47
7.2.16 Smoke Alarm	47
7.2.17 Rect Fault.....	47
7.2.18 Rect Protection.....	47
7.2.19 Single Rect Fault.....	48
7.2.20 Multi-Rect. Fault.....	48
7.2.21 Rect Comm Fault.....	48
7.3 Identifying Faults.....	49
7.3.1 Identifying Rectifier Faults	49
7.3.2 Identifying SMU Faults	50
7.3.3 Identifying PDU Faults	51
7.4 Replacing Components	51
7.4.1 Replacing a Rectifier	51
7.4.2 Replacing an SMU.....	52
7.4.3 Replacing a Battery String	53
A Appendix	55
A.1 Technical Specifications	55
A.2 Electrical Conceptual Diagram	58
B Acronyms and Abbreviations	59

1 Safety Precautions

1.1 General Safety

- Ensure that the product is used in an environment that meets the product design specifications (such as the grid power, input voltage, temperature, and humidity) to avoid causing malfunctions, damaging components, or voiding the warranty.
- Follow the precautions and special safety instructions provided by Huawei when operating this product. Personnel who plan to install or maintain Huawei equipment must receive a thorough training, understand all necessary safety precautions, and be able to correctly perform all operations. Huawei will not be liable for any consequences that are caused by the violation of general safety regulations and equipment usage safety standards.
- Comply with local laws and regulations. The safety instructions in this document are only supplements to local laws and regulations.
- Do not operate the product or handle cables during thunderstorms.
- Do not expose the equipment to flammable or explosive gas or smoke.
- Do not use water to clean electrical components inside or outside of the product.
- To avoid electric shock, do not connect safety extra-low voltage (SELV) circuits to telecommunication network voltage (TNV) circuits.
- Before using the product, remove any conductors such as jewelry or watches.
- Use insulated tools for all operations that involve electrical connections.
- Follow specified procedures during installation and maintenance. Do not attempt to alter the product or deviate from the recommended installation procedures without prior consent from the manufacturer.
- Measure contact point voltage with an electric meter before handling a conductor surface or terminal. Ensure that the contact point has no voltage or the voltage is within the specified range.
- When installing or removing power cables, ensure that the corresponding circuits are disconnected to prevent electric arcs or sparks.
- Performing maintenance or replacing components may interrupt power to the loads if batteries are not connected or the battery reserve is insufficient. Ensure that the switches for primary loads are in the ON position and do not turn off the battery switch and the AC input switch at the same time.
- Cables stored at subzero temperatures must be stored at room temperature for at least 24 hours before they are laid out.

- Perform routine maintenance as described in this manual; replace faulty components at the earliest.

1.2 Electrical Safety

Grounding

- When installing a device, install the ground cable first. When uninstalling a device, remove the ground cable at the very end.
- Before operating a device, ensure that the device is properly grounded. Ensure that the ground cable is installed securely. Inappropriate grounding may cause device damage and even personal injury.

AC and DC Power



DANGER

- The power system is powered by high-voltage power sources. Direct or indirect contact (through damp objects) with high-voltage power sources may result in serious injury or death.
 - Non-standard and improper operations may result in fire or electric shocks.
-
- Before making electrical connections, turn off the protection switch on the upstream device to cut the power supply.
 - Before connecting the AC power supply, ensure that electrical connections are complete.
 - Before you connect cables to loads or battery cables, check cable and terminal polarities to prevent reverse connections.

ESD

- To prevent electrostatic-sensitive components from being damaged by static from human bodies, wear a grounded electrostatic discharge (ESD) wrist strap or ESD gloves when touching circuit boards.
- When holding a board, hold its edge without touching any components, especially chips.
- Package boards with ESD packaging materials before storing or transporting them.

Liquid Prevention

- Do not place the product under areas prone to water leakage, such as near air conditioner vents, ventilation vents, or feeder windows of the equipment room. Ensure that there is no condensation inside the product or equipment room. Ensure that no liquid enters the product. Otherwise, short circuits will occur and may result in serious injury or death.
- If any liquid is detected inside the product, immediately disconnect the power supply and contact the administrator.

1.3 Battery Safety

Before installing, operating, or maintaining the batteries, read the battery manufacturer's safety instructions. Observe the safety precautions provided in this section, which are supplemental to the safety instructions provided by the battery manufacturer.

Basic Requirements

- Avoid skin contact with electrolyte overflow. Before installing or maintaining batteries, wear goggles, rubber gloves, and protective clothing.
- When handling a battery, ensure that its electrodes always point upward. Do not tilt or overturn batteries.
- Switch off the battery circuit breaker or remove the battery fuse before installation and maintenance.
- Secure battery cables to the torque specified in the battery documentation. Loose connections will result in excessive voltage drop or cause batteries to burn out in the case of excessive current.
- Ensure that the load bearing capacity is sufficient in the installation place. For example, add a support to mitigate the load of the floor.
- Install batteries in a dry and, clean, and ventilated environment that is free from sources of ignition. Avoid direct exposure to sunlight or rain water.
- Keep batteries away from strong infrared radiation, organic solvents, and corrosive gas.
- Do not immerse battery cables in water or expose them to rain water.

Battery Short Circuit



DANGER

High short circuit currents or electric shocks can cause equipment damage, personal injury, or death.

To prevent short circuit or electric shock, disconnect the batteries before performing operation or maintenance.

Flammable Gas



NOTICE

- Do not use unsealed lead-acid batteries.
- Lead-acid batteries emit flammable gas. Therefore, place and secure lead-acid batteries horizontally to prevent fire or corrosion.

Store lead-acid batteries in a place with good ventilation, and take fire safety precautions.

Battery Leakage



NOTICE

High temperatures may result in battery distortion, damage, and electrolyte overflow.

If the battery temperature is higher than 60 °C, battery electrolyte may overflow. If the electrolyte overflows, wear goggles, rubber gloves, and protective clothing and absorb the leaking electrolyte using sodium bicarbonate (NaHCO₃) or sodium carbonate (Na₂CO₃). Do not transport or move batteries if there is an electrolyte leakage.

Battery Overdischarge

After connecting the batteries, remove the battery fuse or turn the battery circuit breaker OFF and then powering on the power system. This prevents battery overdischarge. After the power system is on, replace the battery fuse or turn the battery circuit breaker ON.

1.4 Cable Layout

- Cables must be routed so that a sufficient distance exists between the cables and the DC busbar, shunt, and fuse. This prevents damage to the insulation layer of the cables.
- Signal cables must be bound separately from power cables.
- Cables must have a fire resistance rating of VB or higher.
- Cables must not be routed behind the air exhaust vents of rectifiers in the cabinet.
- All cables must be securely bound.

1.5 Mechanical Safety

Hoisting Devices



DANGER

Do not walk under hoisted objects.

- Only trained and qualified personnel are allowed to perform hoisting operations.
- Before hoisting objects, check that all hoisting tools are available and in good condition.
- Before hoisting objects, ensure that hoisting tools are firmly fixed onto a weight-bearing object or wall.
- Ensure that the angle formed by the two hoisting cables is less than 90 degrees.
- If metal hoisting cables are used, add protective pads in the positions where the cables will come in contact with the cabinet to avoid scratching the cabinet surface.

Figure 1-1 Hoisting heavy objects

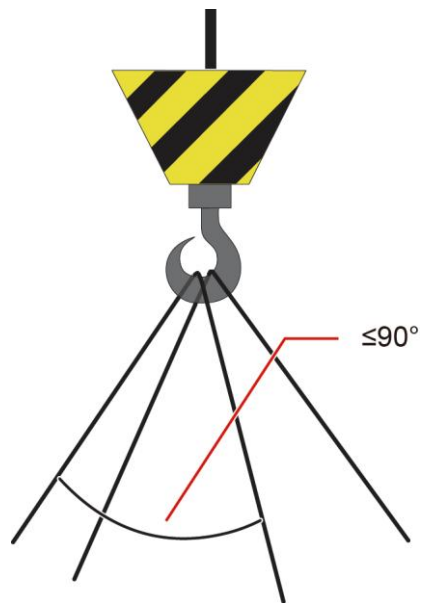

Drilling Holes



NOTICE

Do not drill holes into a cabinet without permission. Non-standard drilling may affect the electromagnetic shielding of the cabinet and damage interior cables. Metal shavings from drilling may short-circuit circuit boards if they enter the cabinet.

- Before drilling holes into a cabinet, remove interior cables.
- Wear goggles and protective gloves when drilling holes.
- After drilling, clean up metal shavings immediately.

Moving Heavy Objects

- Be cautious to prevent injury when moving heavy objects.
- Wear protective gloves when moving heavy objects.

2 Overview

2.1 Introduction

The ETP4830-A1 is a box-type power system that supplies power for -48 V DC communications equipment. It uses 15 A rectifiers and provides a maximum output current of 30 A.

2.2 Model Number Description

Figure 2-1 shows the ETP4830-A1 model number description.

Figure 2-1 ETP4830-A1 model number description

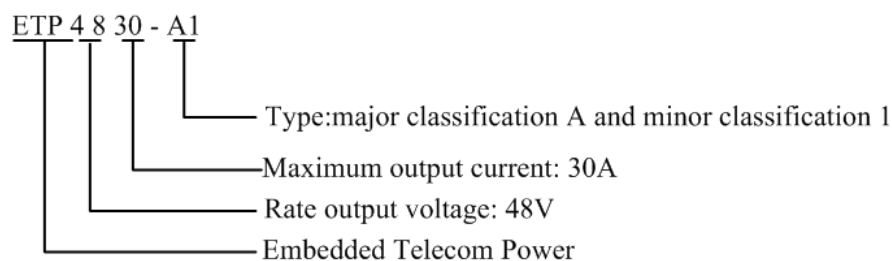

2.3 Features

The ETP4830-A1 has the following features:

- Supports a wide voltage range of 85 V AC to 300 V AC.
- Provides comprehensive battery management.
- The SMU01A communicates with Huawei Network Ecosystem (NetEco) and third-party element management systems (EMSs) over various security protocols, such as the Simple Network Management Protocol (SNMP) and Hypertext Transfer Protocol Secure (HTTPS), featuring flexible networking. It provides WebUI and implements remote unattended management.
- The SMU01B connects to the U2000 over Huawei master/slave protocols.

- Displays information on a liquid crystal display (LCD) and provides buttons for operations.
- Supports electronic labels.
- Rectifiers and the site monitoring unit (SMU) are hot-swappable.
- Allows high-efficiency and standard-efficiency rectifiers with the same capacity to coexist.
- The rectifier power factor is 0.99.

2.4 Configuration

Table 2-1 ETP4830-A1 configuration

Item	Configuration		
PDU	AC input	230 V AC single-phase three-wire (L, N), compatible with 230 V AC dual-live-wire (L, L)	
	DC power distribution	Battery fuse	One 20 A
		Load fuse	Two 20 A
SMU	The following SMUs are supported: <ul style="list-style-type: none"> • One SMU01A • One SMU01B • One SMU01C 		
Rectifier	The following rectifiers are supported: <ul style="list-style-type: none"> • One to two R4815G1s • One to two R4815N1s NOTE <ul style="list-style-type: none"> • The R4815G1 and R4815N1 can be installed together. 		

Figure 2-2 ETP4830-A1 exterior

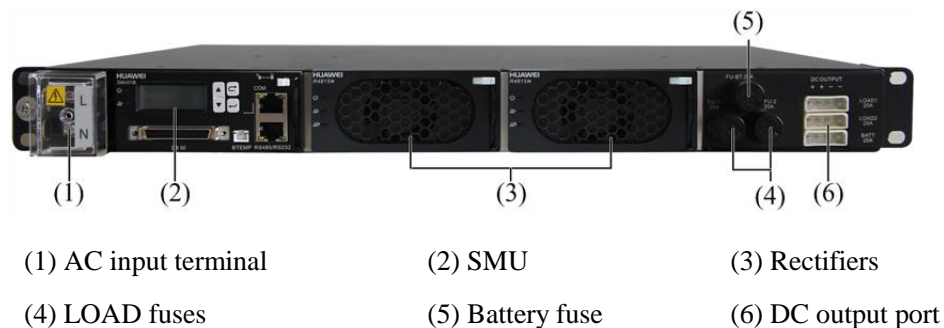

- (1) AC input terminal (2) SMU (3) Rectifiers
 (4) LOAD fuses (5) Battery fuse (6) DC output port



NOTICE

Do not exchange the SMU slot with the rectifier slot. Otherwise, the SMU and rectifier may be damaged.

3 Components

3.1 AC/DC Power Distribution Subrack

Figure 3-1 AC/DC power distribution subrack



3.2 Rectifier

Rectifiers convert AC input into stable DC output.

Figure 3-2 Rectifier

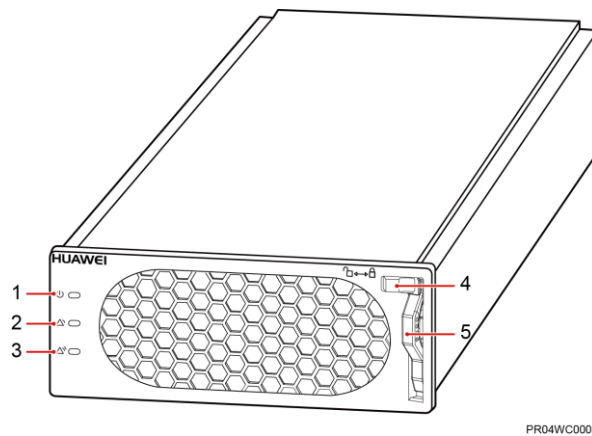

PR04WC0008

- (1) Power indicator
- (2) Alarm indicator
- (3) Fault indicator
- (4) Locking latch
- (5) Handle

Table 3-1 Rectifier indicators

Indicator	Color	Status	Description
Power indicator	Green	Steady on	The rectifier has an AC power input.
		Off	The rectifier has no AC power input.
			The rectifier is faulty.
		Blinking at 0.5 Hz	The rectifier is being queried.
Blinking at 4 Hz	The rectifier is loading an application program.		
Alarm indicator	Yellow	Off	No alarm is generated.
		Steady on	<ul style="list-style-type: none">The rectifier generates an alarm for power limiting due to ambient overtemperature.The rectifier generates an alarm for shutdown due to ambient overtemperature or undertemperature.
			The rectifier protects against AC input overvoltage or undervoltage.
			The rectifier is hibernating.
Blinking at 0.5 Hz	The communication between the rectifier and the SMU is interrupted.		
Fault indicator	Red	Off	The rectifier is running properly.
		Steady on	The rectifier locks out due to output overvoltage.
The rectifier has no output due to an internal fault.			

3.3 SMU

3.3.1 SMU01A

Appearance

Figure 3-3 SMU01A

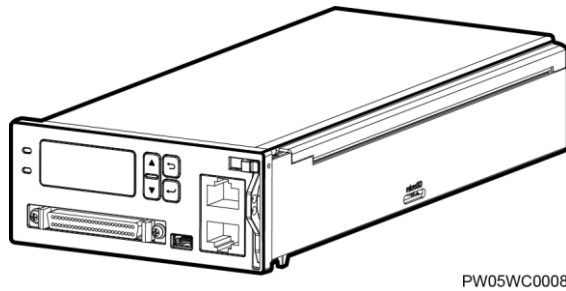

Panel



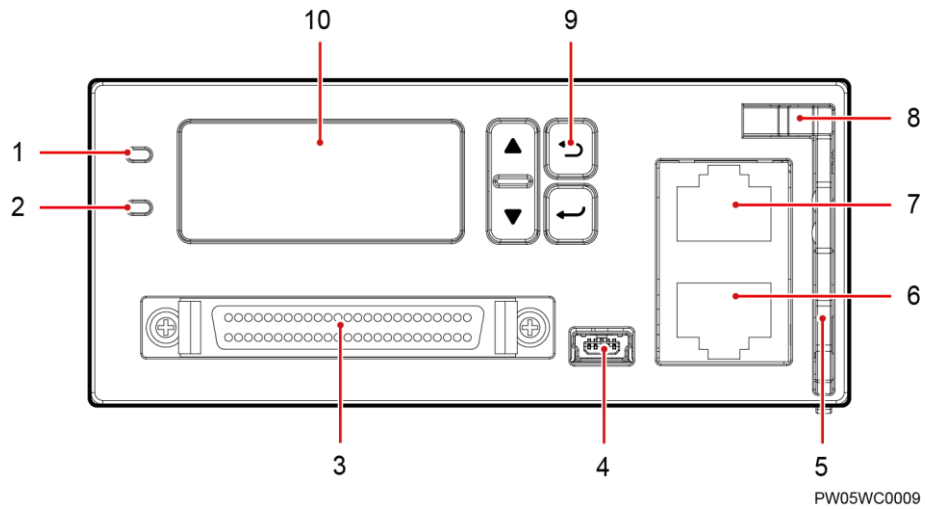

Figure 3-4 SMU01A panel



- | | | |
|-----------------------------------|---------------------|----------------------|
| (1) Run indicator | (2) Alarm indicator | (3) DB50 port |
| (4) USB port (reserved) | (5) Handle | (6) RS485/RS232 port |
| (7) COM port | (8) Locking latch | (9) Four buttons |
| (10) Liquid crystal display (LCD) | | |

Buttons

Table 3-2 Button description

Button	Name	Description
 or 	Up or Down	Allows you to view menu items and set the value of a menu item.
	Back	Returns to the previous menu without saving the settings.
	Enter	<ul style="list-style-type: none"> Enters the main menu from the standby screen. Enters a submenu from the main menu. Saves the menu settings.
<p>NOTE</p> <ul style="list-style-type: none"> The LCD screen becomes dark if no button is pressed within 5 minutes. You need to log in again if no button is pressed within 8 minutes. 		

Communications Ports

Table 3-3 Communications ports

Port	Communications Mode	Communications Parameters
COM	FE	Autonegotiation
	RS485/RS232	Baud rate: 9600 bits/s or 19,200 bits/s
RS485/RS232	RS485/RS232	Baud rate: 9600 bits/s or 19,200 bits/s
<p>NOTE</p> <p>All the preceding ports are protected by a security mechanism.</p>		

Figure 3-5 Communication port

RJ45 female connector

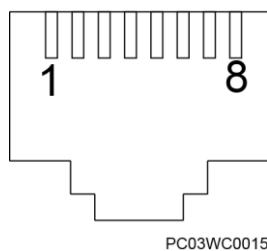

Table 3-4 describes the pins in the COM port that is used as an FE port. Table 3-5 describes the pins in the COM port that is used as an RS485/RS232 port.

Table 3-4 Pins in the COM port (used as an FE port)

Pin	Signal	Description
1	TX+	Sends data over FE.
2	TX-	
3	RX+	Receives data over FE.
6	RX-	
4, 5, 7, 8	None	N/A

Table 3-5 Pins in the RS485/RS232 port

Pin	Signal	Description
1	TX+	Sends data over RS485.
2	TX-	
4	RX+	Receives data over RS485.
5	RX-	
3	RX232	Receives data over RS232.
7	TX232	Sends data over RS232.
6	PGND	Connects to the ground.
8	None	N/A

3.3.2 SMU01B

Appearance

Figure 3-6 SMU01B



Panel



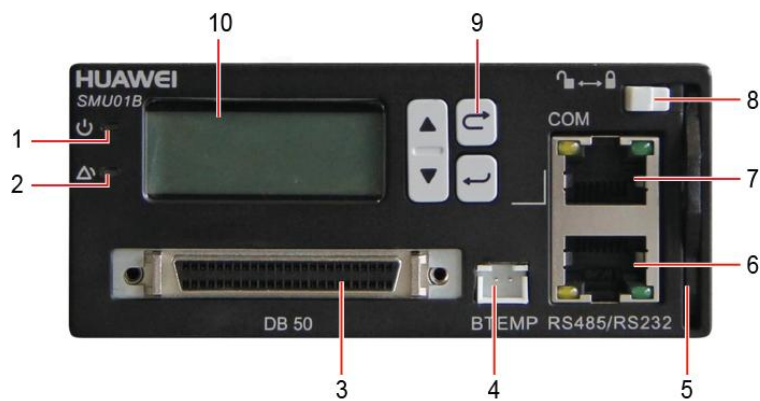

Figure 3-7 SMU01B panel



- | | | |
|-------------------------------------|---------------------|----------------------|
| (1) Run indicator | (2) Alarm indicator | (3) DB50 port |
| (4) Battery temperature sensor port | (5) Handle | (6) RS485/RS232 port |
| (7) COM port | (8) Locking latch | (9) Four buttons |
| (10) Liquid crystal display (LCD) | | |

Buttons

Table 3-6 Button description

Button	Name	Description
 or 	Up or Down	Allows you to view menu items and set the value of a menu item.
	Back	Returns to the previous menu without saving the settings.
	Enter	<ul style="list-style-type: none"> Enters the main menu from the standby screen. Enters a submenu from the main menu. Saves the menu settings.
<p>NOTE</p> <ul style="list-style-type: none"> The LCD screen becomes dark if no button is pressed within 5 minutes. You need to log in again if no button is pressed within 8 minutes. 		

Communications Ports

Table 3-7 Communications ports

Port	Communications Mode	Communications Parameters
COM	RS485/RS232	Baud rate: 9600 bits/s or 19,200 bits/s
RS485/RS232	RS485/RS232	Baud rate: 9600 bits/s or 19,200 bits/s
<p>NOTE</p> <p>All the preceding ports are protected by a security mechanism.</p>		

Figure 3-8 Communication port

RJ45 female connector

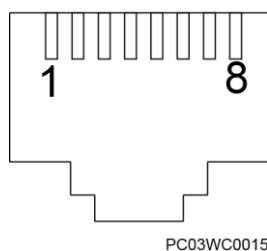

PC03WC0015

[Table 3-8](#) describes the pins in the COM port and RS485/RS232 port.

Table 3-8 Pins in the RS485/RS232 port

Pin	Signal	Description
1	TX+	Sends data over RS485.
2	TX-	
4	RX+	Receives data over RS485.
5	RX-	
3	RX232	Receives data over RS232.
7	TX232	Sends data over RS232.
6	PGND	Connects to the ground.
8	None	N/A

3.3.3 SMU01C

Appearance

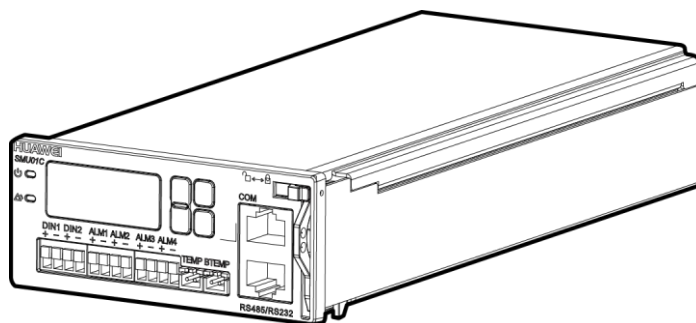
Figure 3-9 SMU01C

PC09WC0001

Panel

Figure 3-10 SMU01C panel

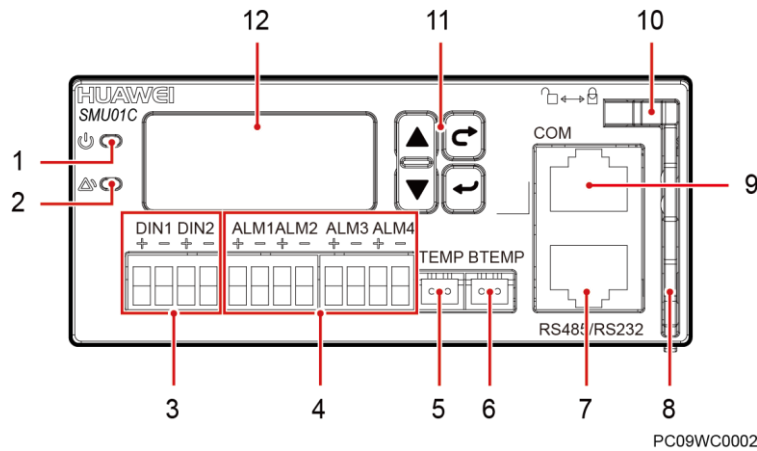

- (1) Run indicator
- (2) Alarm indicator
- (3) Boolean value input ports
- (4) Dry contact output ports
- (5) Ambient temperature sensor port
- (6) Battery temperature sensor port
- (7) RS485/RS232 port
- (8) Handle
- (9) COM port
- (10) Locking latch
- (11) Four buttons
- (12) Liquid crystal display (LCD)

Dry contact ports





Table 3-9 Dry contact ports description

Port Type	Silk-screen	Description	Default Alarms
Boolean value input port	DIN1	Boolean value input 1	Reserved
	DIN2	Boolean value input 2	Reserved
Dry contact output port	ALM1	Dry contact output 1	Major Mains Fault, DC Over Volt, DC Under Volt, Batt Off, Batt Loop Trip, Rect Fault, Load Fuse Trip
	ALM2	Dry contact output 2	Minor AC Over Volt, AC Under Volt, Amb. Over Temp1, Amb. Under Temp1, Batt Over Temp, Batt Under Temp, Rect Protect, Rect Comm Fail, Batt Over Curr, Dig. Input1 ALM, Dig. Input2 ALM, Batt Discharge

Port Type	Silk-screen	Description	Default Alarms
	ALM3	Dry contact output 3	Reserved
	ALM4	Dry contact output 4	Reserved

Buttons

Table 3-10 Button description

Button	Name	Description
 or 	Up or Down	Allows you to view menu items and set the value of a menu item.
	Back	Returns to the previous menu without saving the settings.
	Enter	<ul style="list-style-type: none">• Enters the main menu from the standby screen.• Enters a submenu from the main menu.• Saves the menu settings.
NOTE <ul style="list-style-type: none">• The LCD screen becomes dark if no button is pressed within 5 minutes.• You need to log in again if no button is pressed within 8 minutes.		

Communications Ports

Table 3-11 Communications ports

Port	Communications Mode	Communications Parameters
COM	RS485/RS232	Baud rate: 9600 bits/s or 19,200 bits/s
RS485/RS232	RS485/RS232	Baud rate: 9600 bits/s or 19,200 bits/s
NOTE All the preceding ports are protected by a security mechanism.		

Figure 3-11 Communication port

RJ45 female connector

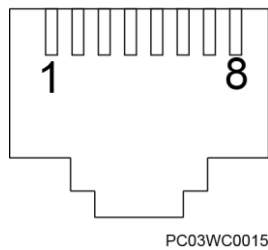

Table 3-12 describes the pins in the COM port and RS485/RS232 port.

Table 3-12 Pins in the RS485/RS232 port

Pin	Signal	Description
1	TX+	Sends data over RS485.
2	TX-	
4	RX+	Receives data over RS485.
5	RX-	
3	RX232	Receives data over RS232.
7	TX232	Sends data over RS232.
6	PGND	Connects to the ground.
8	None	N/A

4 Installation

4.1 Installing a Subrack

Procedure

Step 1 Install the floating nuts.

Figure 4-1 Installing floating nuts

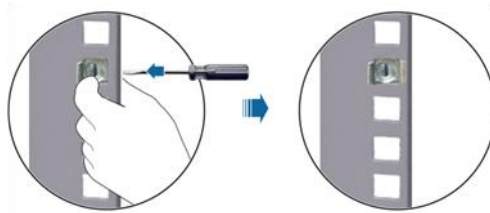

Step 2 Install the ETP4830-A1 in a 19-inch rack.

Figure 4-2 Installing a subrack

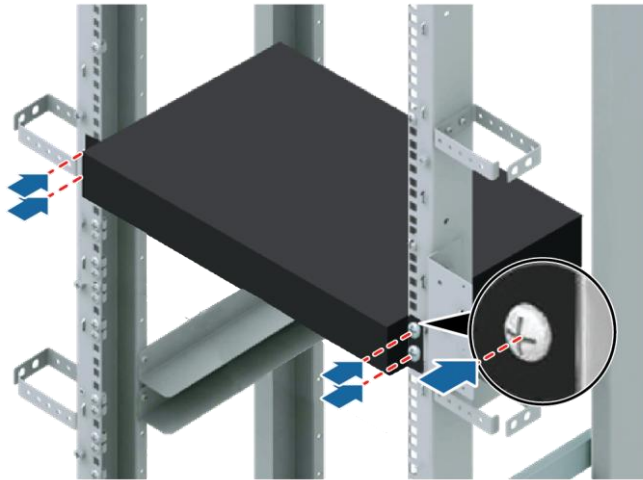

NOTE

The ETP4830-A1 can be installed in a European Telecommunications Standards Institute (ETSI) rack if the required mounting ears are available.

----End

4.2 Installing Components

4.2.1 Installing an SMU

Procedure

- Step 1** Insert a new SMU into the slot, push the locking latch towards the left, and pull out the handle.
- Step 2** Slide the SMU into the subrack along the guide rail, push in the handle, and then push the locking latch towards the right.

Figure 4-3 Installing an SMU

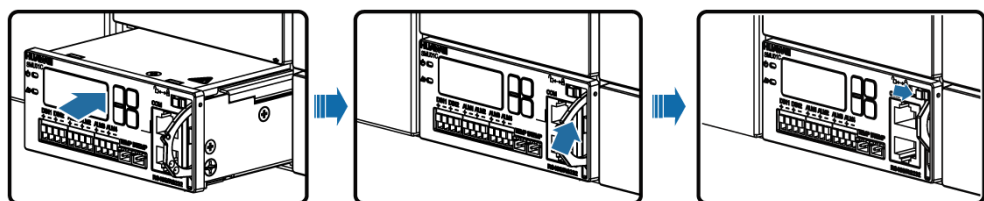

PQ071C0001

----End

4.2.2 Installing a Rectifier

Procedure

- Step 1** Push the locking latch towards the left.
- Step 2** Draw the handle downwards.
- Step 3** Insert the rectifier into the slot and slide the rectifier into the subrack along the guide rail.
- Step 4** Push the handle upwards.
- Step 5** Push the locking latch towards the right to secure the handle.

Figure 4-4 Installing rectifiers

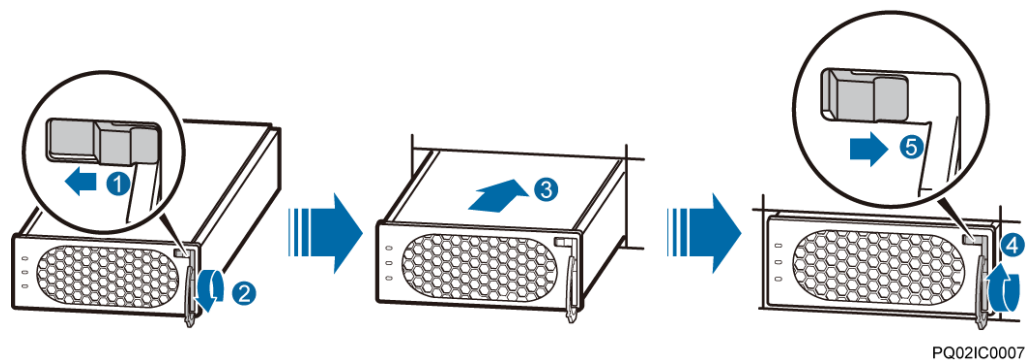

----End

4.3 Connecting Cables



DANGER

- Ensure that the upstream AC input circuit breaker is OFF, and attach labels such as "No operations allowed."
- Before installing cables, switch all the circuit breakers to OFF, and remove the fuses from positions where cables will be installed.

4.3.1 Connecting the Ground Cable

Figure 4-5 shows how to connect the ground cable (an M4 OT terminal is used for the cable).

Figure 4-5 Connecting the ground cable



(1) Ground bar

4.3.2 (Optional) Installing Dry Contact Signal Cables

Procedure

- Step 1** Press the contact plate using a flat-head screwdriver to flip the metal spring inside each dry contact.
- Step 2** Connect the signal cables to the corresponding dry contacts.
- Step 3** Put away the flat-head screwdriver and check that the signal cables are securely connected.

Figure 4-6 Installing a dry contact signal cable

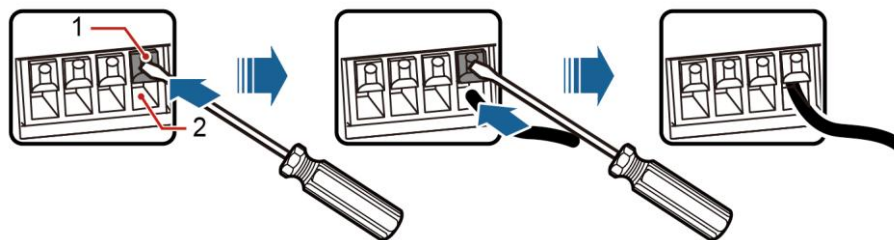

PO01IC3002

(1) Contact plate

(2) Dry contact port

----End

4.3.3 Connecting the Communications Cable

Connecting a Communications Cable to the SMU01A

Connect a communications cable to the COM port on the SMU01A when you use the Web UI, NetEco, or SNMP to remotely manage the power supply system, as shown in [Figure 4-7](#).

Figure 4-7 Connecting a communications cable to the SMU01A COM port

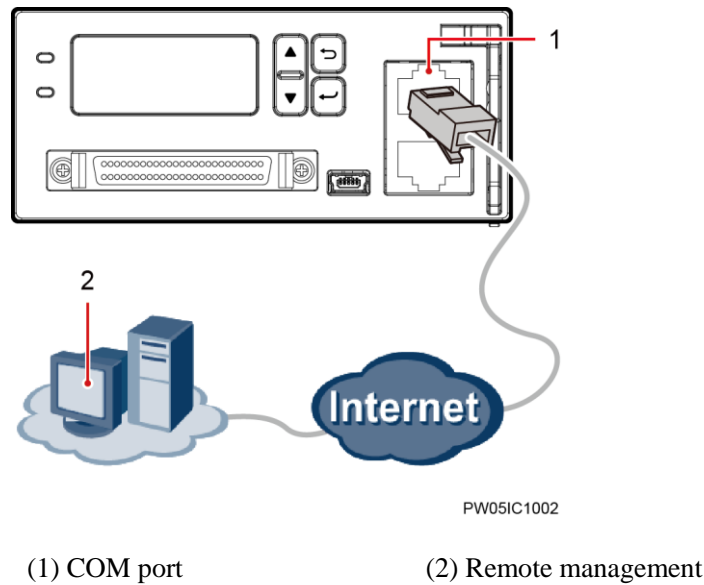

Connecting a Communications Cable to the SMU01B

Connect the COM port on the SMU01B to the corresponding serial port on the Huawei access network communications equipment using a communications cable when you use the U2000 network management system to remotely manage the power supply system, as shown in Figure 4-8.

Figure 4-8 Connecting a communications cable to the SMU01B COM port

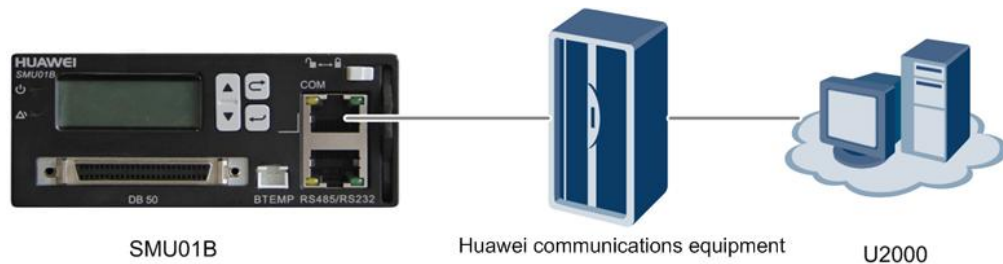

Connecting a Communications Cable to the SMU01C

Alarm signals of the power system can be uploaded through dry contacts. Connect the dry contact signal cable to the EXT-ALM port on the BBU.

Figure 4-9 Connecting the SMU01C and the BBU

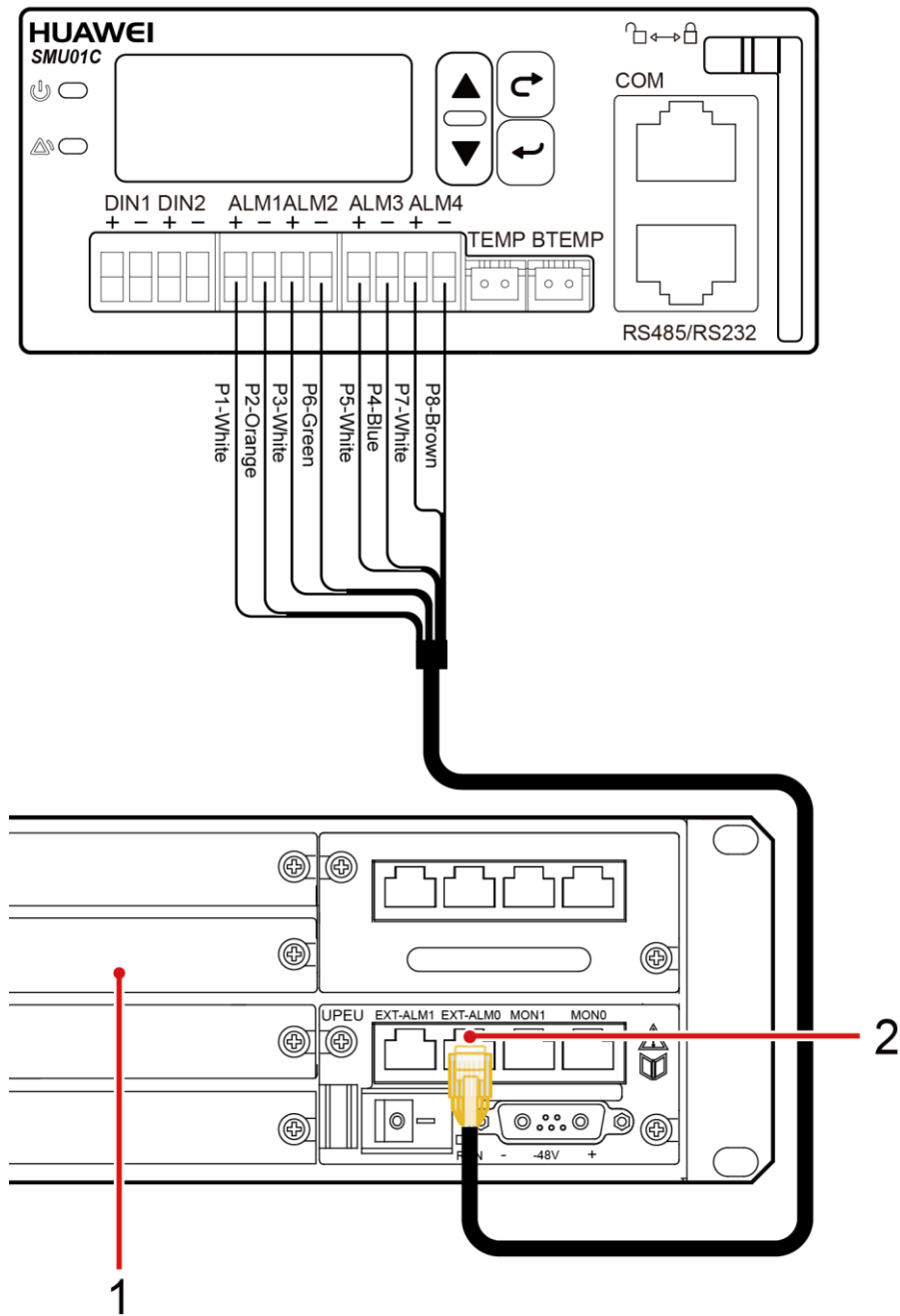

PO09I20004

(1) BBU

(2) EXT-ALM0 port

4.3.4 Connecting the DC Load Cable

Procedure

Step 1 Connect the DC load cable.

Figure 4-10 Connecting the load cable

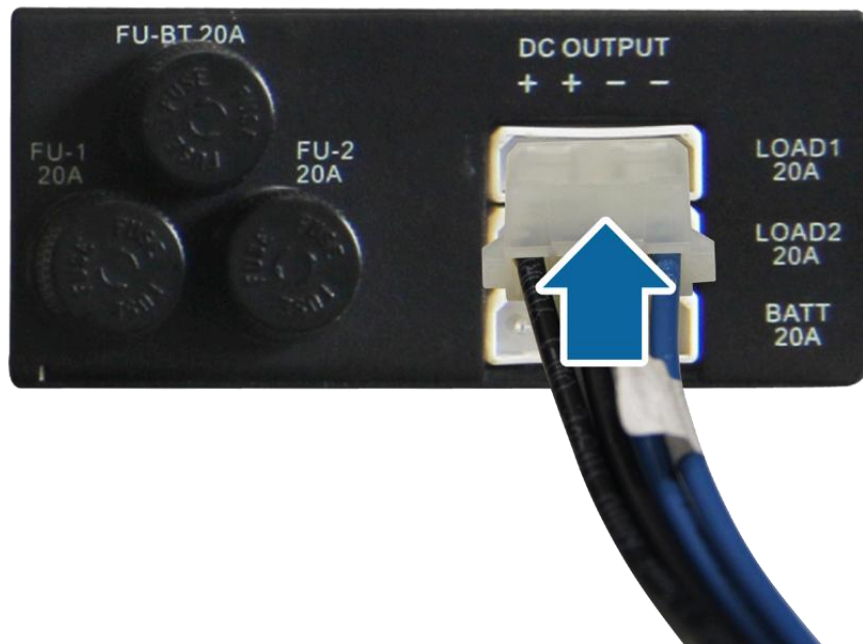

----End

4.3.5 Connecting the Battery Cable

Connecting battery cables is similar to connecting load cables. For details, see [4.3.4 Connecting the DC Load Cable](#).

4.3.6 Connecting the AC Input Power Cable



DANGER

Before connecting the AC input power cable:

- Install a circuit breaker for upper-level device to protect the power system.
- Switch the corresponding circuit breaker for the upper-level device to OFF.

Connecting the 230 V AC Single-Phase of TN 400 V Net or TT 400 V Net Input Power Cable

Procedure

- Step 1** Remove the protective cover over AC input terminals.
- Step 2** Connect the neutral wire (an M4 OT terminal is used for the cable) to the wiring terminal marked as N.

- Step 3** Connect the live wire (an M4 OT terminal is used for the cable) to the wiring terminal marked as L.

Figure 4-11 Connecting the single-phase AC input power cable



- Step 4** Reinstall the protective cover.

----End

Connecting the Dual-Live of IT 230V Net or TN 208V Net AC Input Power Cable

Procedure

- Step 1** Remove the protective cover over AC input terminals.
- Step 2** Connect the L1 wire (an M4 OT terminal is used for the cable) to the wiring terminal marked as L.
- Step 3** Connect the L2 wire (an M4 OT terminal is used for the cable) to the wiring terminal marked as N.

Figure 4-12 Connecting the dual-live wire AC input power cable



- Step 4** Reinstall the protective cover.

----End

5 Verifying the Installation

5.1 Checking Hardware Installation

- Check that all screws, especially those used for electrical connections, are secured. Check that flat washers and spring washers are installed properly.
- Check that rectifiers are completely inserted into their respective slots and properly locked.

5.2 Checking Electrical Connections

- Check that all circuit breakers or fuses are OFF.
- Check that flat washers and spring washers are securely installed for all OT terminals and that all the OT terminals are intact and properly connected.
- Check that batteries are correctly installed and that battery cables are correctly connected and not short-circuited.
- Check that input and output power cables and ground cables are correctly connected and not short-circuited.

5.3 Checking Cable Installation

- Check that all cables are securely connected.
- Check that all cables are arranged neatly and bound properly to their nearest cable ties, and are not twisted or overly bent.
- Check that cable labels are properly and securely attached in the same direction.

6 Commissioning



NOTICE

- The following commissioning procedure may result in power failure or alarms. Inform the alarm center before and after the procedure.
- Commissioning involves various technologies, requires trained personnel, and requires compliance with commissioning instructions.
- Commissioning is performed with the power on. Remove metal items such as watches and necklaces, stand on dry insulating material, and use insulated tools.
- Do not contact two electric bodies that have different currents during operations.
- During commissioning, check that the status of the related unit or component meets requirements before turning on any switch.
- When you are performing operations and do not want others to operate, attach the label "Do not turn on the switch because operations are in process." to the power distribution device.
- During commissioning, shut down the device immediately if any fault is detected. Rectify the fault and proceed with the commissioning.



6.1 Connecting the AC Power Supply

Procedure

- Step 1** Check whether the voltage across the input ports of AC input circuit breakers for the upper-level device is the same as the local voltage. If no, ask professionals to rectify the fault.
- Step 2** Switch on the AC input circuit breakers for the upper-level device.
- Step 3** Observe the Run indicator (green) on the rectifier panel. If it is steady on, the rectifier is powered on successfully.
- Step 4** Observe the Run indicator (green) and LCD on the SMU panel. If the indicator is blinking and the LCD is on, the SMU is powered on successfully.

----End

6.2 Setting the Display Language

After powering on the SMU, press  or  on the LCD to select a display language. Then press  to enter the standby screen.



NOTE

If an undesired language is selected, reinstall and restart the SMU and then select the desired language.

6.3 Setting Time and Date

6.3.1 SMU01A

Set the time and date for the SMU01A as required.

Table 6-1 Time and date parameters for the SMU01A

Main Menu	Second-Level Menu	Third-Level Menu	Default Value	Setting
Settings	System Para	Set Date	-	Local date
		Set Time	-	Local time
		Set Time Zone	GMT+08:00	Local time zone



NOTE

The preset user name of SMU01A is **admin**, and the preset password is **001**.

6.3.2 SMU01B and SMU01C

Set the time and date for the SMU01B and SMU01C as required.

Table 6-2 Time and date parameters for the SMU01B and SMU01C

Main Menu	Second-Level Menu	Third-Level Menu	Default Value	Setting
Settings	System Settings	Date	-	Local date
		Time	-	Local time



NOTE

- The preset user name of SMU01B is **admin**, and the preset password is **00200**.
- The preset user name of SMU01C is **admin**, and the preset password is **000001**.

6.4 Setting System Type

If the SMU01A is configured, set the system type based on the actual situation, as described in [Table 6-3](#). If the SMU01B or SMU01C is configured, you do not need to reset the system type.

Table 6-3 Setting system type

Main Menu	Second-Level Menu	Third-level Menu	Default Value	Setting Value
Settings	Site Summary	System Type	Standard	ETP4830

6.5 Setting Battery Parameters



NOTICE

If battery parameters are incorrectly set, batteries will deteriorate early. Set the parameters strictly based on actual requirements.

6.5.1 SMU01A

Set **Qty of Battery** to **1**, set **Rated Capacity** to the total capacity of battery strings, and set **Charge Coef** as required.

Table 6-4 Battery parameters for the SMU01A

Main Menu	Second-Level Menu	Default Value	Setting
Quick Settings	Qty of Battery	1	1
	Rated Capacity	65 Ah	Battery string capacity
	Charge Coef	0.15C10	Range: 0.05C10-0.25C10

6.5.2 SMU01B and SMU01C

Set **Battery String** to **1**, set **Capacity** to the total capacity of battery strings, and set **Charge Coef** as required.

Table 6-5 Battery parameters for the SMU01B and SMU01C

Main Menu	Second-Level Menu	Third-Level Menu	Default Value	Setting
Settings	Batt Settings	Battery String	1	1
		Capacity	40 Ah	Battery string capacity
		Charge Coef	0.15C10	Range: 0.05C10-0.25C10

6.6 (Optional) Setting DC Parameters

Set DC parameters as required.

Table 6-6 DC parameters

Main Menu	Second-Level Menu	Third-Level Menu	Default Value	Range
Settings	DC Settings	FC Volt	53.5 V	47.0V-56.5V (\leq BC Volt)
		BC Volt	56.5 V	53.5V-57.0V (FC Volt \leq BC Volt \leq DC Over Volt – 1V)
		Over Volt	58.0 V	58.0V-60.0V
		Under Volt	45.0 V	43.1V-51.5V
		BLVD Enable	Yes	Yes, No
		BLVD Volt	43.0 V	38.0V-44.9V

6.7 (Optional) Setting Hibernation Parameters

6.7.1 SMU01A

Set **Rect Redund En** to **Enable** if you need to use the intelligent hibernation function of the rectifiers.

Table 6-7 Hibernation parameter for the SMU01A

Main Menu	Second-Level Menu	Third-Level Menu	Default Value	Setting
Settings	PSU Summary	Rect Redund Ena	Disable	Enable

6.7.2 SMU01B and SMU01C

Set **Sleep Enable** to **Yes** if you need to use the intelligent hibernation function of the rectifiers.

Table 6-8 Hibernation parameter for the SMU01B and SMU01C

Main Menu	Second-Level Menu	Third-Level Menu	Default Value	Setting
Settings	Rect Settings	Sleep Enable	No	Yes

6.8 (Optional) Setting Alarm Parameters

6.8.1 SMU01A

Set the following alarm parameters as required if you need to enable the alarm function or modify the alarm severity and relay association.

Table 6-9 Alarm parameters for the SMU01A

Main Menu	Second-Level Menu	Third-Level Menu	Fourth-Level Menu	Default Value	Setting
Settings	Alarm Setting	Site Summary	Internal Fault	Enable	Set the parameter as required.
			NOTE Take the Internal Fault alarm as an example.	MA	Set the parameter as required.
			None	Set the parameter as required.	
	Site Summary	DO (1-8) Alarm Act	-	Close	Set the parameter as required.
		DI (1-8)	-	Close	Set the

Main Menu	Second-Level Menu	Third-Level Menu	Fourth-Level Menu	Default Value	Setting
		Alarm			parameter as required.

6.8.2 SMU01B and SMU01C

Set the following alarm parameters as required if you need to enable the alarm function or modify the alarm severity and relay association.

Table 6-10 Alarm parameters for the SMU01B and SMU01C

Main Menu	Second-Level Menu	Third-Level Menu	Fourth-Level Menu	Default Value	Setting	
Settings	Alarm Setting	Alarm Severity	AC Volt Low/High	Major	Set the parameter as required.	
			NOTE Take the AC Over Volt alarm as an example.			
		Digital Alarm	Digital No. 1		High	Set the parameter as required.
			NOTE Take Digital No. 1 as an example.			
			Mode			
		Relay Relate	AC Volt Low/High (Alarm)		None	Set the parameter as required.
			NOTE Take the AC Volt Low/High alarm as an example.			
Relate Relay						
		Default type	NC		Set the parameter as required.	

6.9 (Optional) Setting Communications Parameters

6.9.1 SMU01A

Setting Parameters Before WebUI Management

Before you use the WebUI to remotely manage the SMU01A, set the required IP parameters.

Procedure

- Step 1** Apply to the site or equipment room network administrator for a fixed IP address.
- Step 2** Set the IP address, subnet mask, and gateway address as shown in [Table 6-11](#).

Table 6-11 IP parameters

Main Menu	Second-Level Menu	Default Value	Setting
Quick Settings	IP Address	192.168.0.10	Set this parameter according to the address assigned by the network administrator.
	Subnet mask	255.255.255.0	Set this parameter according to the address assigned by the network administrator.
	Gateway	192.168.0.1	Set this parameter according to the address assigned by the network administrator.

----End

Setting Parameters Before NetEco Management

Before you use the NetEco to perform remote management, set the required parameters.

Procedure

- Step 1** Apply to the site or equipment room network administrator for a fixed IP address.
- Step 2** Set the IP address, subnet mask, and gateway address as shown in [Table 6-12](#).

Table 6-12 IP parameters

Main Menu	Second-Level Menu	Default Value	Setting
Quick Settings	IP Address	192.168.0.10	Set this parameter according to the address assigned by the network administrator.
	Subnet mask	255.255.255.0	Set this parameter according to the address assigned by the network administrator.
	Gateway	192.168.0.1	Set this parameter according to the address assigned by the network administrator.

Step 3 Set the IP addresses and ports for the active and standby servers of the NetEco, as described in [Table 6-13](#).

Table 6-13 NetEco parameters

Main Menu	Second-Level Menu	Third-Level Menu	Default Value	Setting
Settings	Comm Para	NetEco Main IP	58.251.159.136	Set this parameter to the IP address of the active NetEco server.
		NetEco Bak IP	58.251.159.136	Set this parameter to the IP address of the standby NetEco server.
		NetEco Port	31220	Set a port for the NetEco.

----End

Setting Parameters Before SNMP Management

Before you use SNMP to perform remote management, set the required parameters.

Procedure

- Step 1** Apply to the site or equipment room network administrator for a fixed IP address.
- Step 2** Set the IP address, subnet mask, and gateway on the LCD, as described in [Table 6-14](#).

Table 6-14 IP parameters

Main Menu	Second-Level Menu	Default Value	Setting
Quick Settings	IP Address	192.168.0.10	Set this parameter according to the address assigned by the network administrator.
	Subnet mask	255.255.255.0	Set this parameter according to the address assigned by the network administrator.
	Gateway	192.168.0.1	Set this parameter according to the address assigned by the network administrator.

Step 3 Connect the network port on your PC to the FE port on the SMU.



NOTICE

The SMU has only one FE port. Remove the existing network cable from the FE port before you perform step 3 and reconnect the network cable after you finish setting the parameters.

Step 4 Set the PC IP address in the same network segment as the SMU IP address set in step 2.

Assume that the SMU IP address is 192.168.0.10 and its subnet mask is 255.255.255.0. Set the PC IP address to 192.168.0.11 and its subnet mask to 255.255.255.0.

Step 5 Enter the SMU IP address in the address box on the PC. Log in to the WebUI on the login page shown in [Figure 6-1](#).



NOTE

The default user name is **admin**, and the default password is **001**.

Figure 6-1 WebUI login page

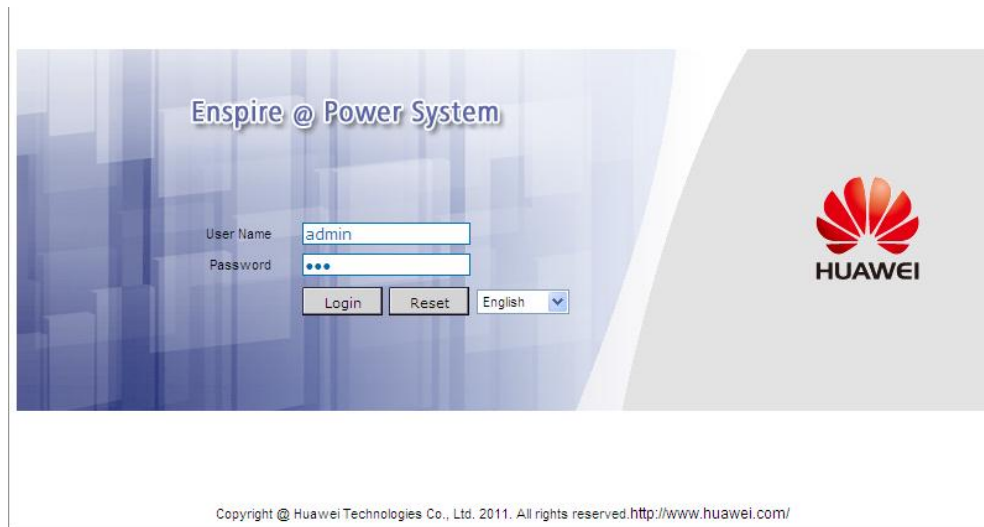

Step 6 On the **Network Configuration** page, select **SNMP**.

1. If the SNMP version is SNMPv1 or SNMPv2c, set **SNMP Port**, **Read Community**, and **Write Community**, as shown in [Figure 6-2](#).

Figure 6-2 SNMPv1 and SNMPv2c parameters

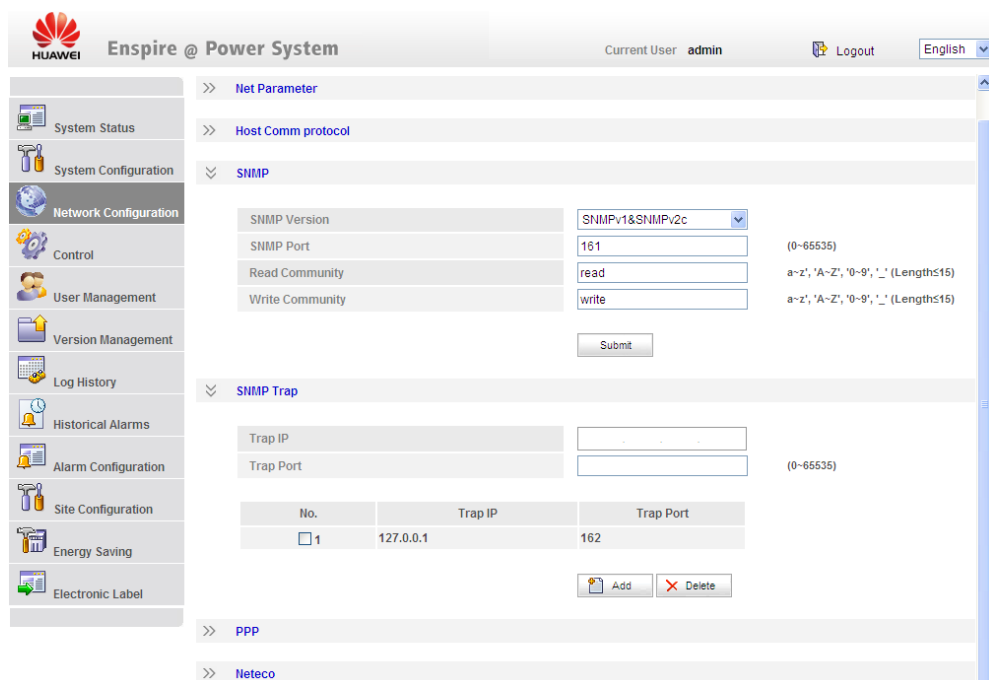

2. If the SNMP version is SNMPv3, set **User Name**, **Authentication Protocol Password**, and **Privacy Protocol Password**, as shown in [Figure 6-3](#).

Figure 6-3 SNMPv3 parameters

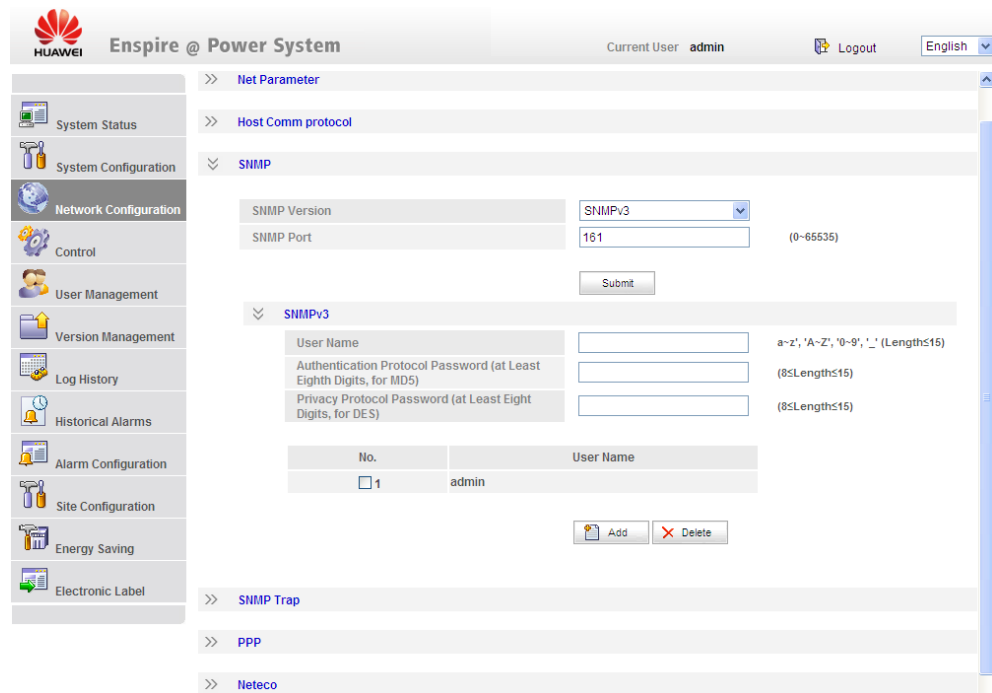

Step 7 Set the SNMP trap destination address and trap port.

Step 8 Upload the MIB libraries **HUAWEI-MIB.mib** and **HUAWEI-SITE-MONITOR-MIB.mib** to the NMS.

----End

6.10 Connecting the Battery Supply

Prerequisites



NOTICE

To avoid damage to batteries, reinstall the battery fuse only after correctly setting the battery parameters for the monitoring unit.

Procedure

Step 1 Switch off the AC circuit breaker for the upper-level device, and then reinstall the battery fuse.

Step 2 Switch on the AC circuit breaker for the upper-level device, and then reinstall the load fuses.

Step 3 Check whether the battery voltage and system output voltage are the same as the voltages displayed on the SMU LCD. If not, ask the technical support personnel to rectify the fault.

Step 4 Set the battery and load circuit breakers based on the site requirements.

Step 5 Observe the power system for 15 minutes. If no alarm is generated on the SMU LCD, the voltage and current for batteries and loads are normal. In this case, clean and leave the site.

----End

7 Maintenance

7.1 Routine Maintenance

Routine maintenance is required periodically based on the site requirements. The recommended maintenance interval is six months. If any fault is detected, rectify it in time.

Table 7-1 Routine maintenance checklist

Item	Maintenance Content			
	Check That	Check Method	Repair When	Measures
Electrical connection	The AC input voltage is normal.	Using a multimeter	The AC input voltage exceeds the threshold.	For details, see 7.2 Rectifying Common Faults and 7.3 Identifying Faults .
	The output voltage is normal.		The battery low voltage disconnection (BLVD) or load low voltage disconnection (LLVD) voltage exceeds the threshold.	
Preventive inspection	The indicators are normal.	Visual observation	Alarms are generated.	
Grounding inspection	The connection between the ground point and the ground bar in the cabinet is normal.	Using a multimeter	The resistance between the ground point and the ground bar is greater than 0.1 ohm.	Secure or replace the ground cable.

7.2 Rectifying Common Faults

7.2.1 Mains Failure

Possible Causes

- The AC input power cable is faulty.
- The upstream AC input circuit breaker is OFF.
- The mains grid is faulty.

Measures

1. Check whether the AC input cable is loose. If yes, secure the AC input cable.
2. Check whether the upstream AC input circuit breaker is OFF. If yes, rectify the back-end circuit fault and then switch on the circuit breaker.
3. Check whether the AC input voltage is lower than 50 V AC. If yes, handle the mains grid fault.

7.2.2 AC Over Volt

Possible Causes

- The AC overvoltage alarm threshold is not set properly on the SMU.
- The power grid is faulty.

Measures

1. Check whether the AC overvoltage alarm threshold is properly set. If no, adjust it to a proper value.
2. Check whether the AC input voltage exceeds the AC overvoltage alarm threshold (280 V AC by default). If yes, handle the AC input fault.

7.2.3 AC Under Volt

Possible Causes

- The AC undervoltage alarm threshold is not set properly on the SMU.
- The power grid is faulty.

Measures

1. Check whether the AC undervoltage alarm threshold is properly set. If no, adjust it to a proper value.
2. Check whether the AC input voltage is below the AC undervoltage alarm threshold (180 V AC by default). If yes, handle the AC input fault.

7.2.4 DC Over Volt

Possible Causes

- The DC overvoltage alarm threshold is not set properly on the SMU.

- The power system voltage is set too high in manual mode.
- Rectifiers are faulty.

Measures

1. Check whether the DC overvoltage alarm threshold (58 V DC by default) is properly set. If no, adjust it to a proper value.
2. Check whether the system voltage is set too high in manual mode. If yes, confirm the reason and adjust the voltage to normal after the operation.
3. Remove the rectifiers one by one and check whether the alarm is cleared. If the alarm still exists, reinstall the rectifier. If the alarm is cleared, replace the rectifier.

7.2.5 DC Under Volt

Possible Causes

- An AC power failure occurs.
- The DC undervoltage alarm threshold is not set properly on the SMU.
- The system configuration is not proper.
- The power system voltage is set too low in manual mode.
- Rectifiers are faulty.

Measures

1. Check whether an AC power failure occurs. If yes, resume the AC power supply.
2. Check whether the DC undervoltage alarm threshold (45 V DC by default) is properly set. If no, adjust it to a proper value.
3. Check whether the load current is greater than the current power system capacity. If yes, expand the power system capacity or reduce the load power.
4. Check whether the system voltage is set too low in manual mode. If yes, confirm the reason and adjust the voltage to a proper value after the operation.
5. Check whether the power system capacity is insufficient for the loads due to rectifier failures. If yes, replace the faulty rectifier.

7.2.6 Amb. Over Temp



NOTE

This alarm is generated only for the power system that has ambient temperature sensors installed.

Possible Causes

- The ambient overtemperature alarm threshold is not set properly on the SMU.
- The temperature control system is faulty in the cabinet where the ambient temperature sensor is located.
- The ambient temperature sensor is faulty.

Measures

1. Check whether the ambient temperature alarm threshold (50 °C by default) is properly set on the SMU. If no, adjust it based on site requirements.

2. Check whether the temperature control system in the cabinet is faulty. If yes, rectify the fault. The alarm is cleared when the cabinet temperature falls within the allowed range.
3. Check whether the ambient temperature sensor is faulty. If yes, replace the temperature sensor.

7.2.7 Amb. Under Temp



NOTE

This alarm is generated only for the power system that has ambient temperature sensors installed.

Possible Causes

- The ambient undertemperature alarm threshold is not set properly on the SMU.
- The temperature control system is faulty in the cabinet where the ambient temperature sensor is located.
- The ambient temperature sensor is faulty.

Measures

1. Check whether the ambient undertemperature alarm threshold (0 °C by default) is properly set on the SMU. If no, adjust it based on site requirements.
2. Check whether the temperature control system in the cabinet is faulty. If yes, rectify the fault. The alarm is cleared when the cabinet temperature falls within the allowed range.
3. Check whether the ambient temperature sensor is faulty. If yes, replace the ambient temperature sensor.

7.2.8 Batt Over Temp



NOTE

This alarm is generated only for the power system that has battery temperature sensor installed.

Possible Causes

- The battery overtemperature alarm threshold is not set properly on the SMU.
- The battery temperature controlling system is faulty.
- The battery temperature sensor is faulty.

Measures

1. Check whether the battery overtemperature alarm threshold (50 °C by default) is properly set. If no, adjust it to a proper value.
2. Check whether the battery temperature controlling system is faulty. If yes, rectify the fault. The alarm is cleared when the battery temperature falls within the allowed range.
3. Check whether the battery temperature sensor is faulty. If yes, replace the temperature sensor.

7.2.9 Batt Under Temp



NOTE

This alarm is generated only for the power system that has battery temperature sensor installed.

Possible Causes

- The battery undertemperature alarm threshold is not set properly on the SMU.
- The battery temperature controlling system is faulty.
- The battery temperature sensor is faulty.

Measures

1. Check whether the battery undertemperature alarm threshold (0 °C by default) is properly set. If no, adjust it to a proper value.
2. Check whether the battery temperature controlling system is faulty. If yes, rectify the fault. The alarm is cleared when the battery temperature falls within the allowed range.
3. Check whether the battery temperature sensor is faulty. If yes, replace the temperature sensor.

7.2.10 Batt Chg. Overcur.

Possible Causes

- The rectifier communication is interrupted.
- Poor contact of the SMU.
- The SMU is faulty.

Measures

1. Check whether an alarm is generated for rectifier communication interruption. If yes, remove the rectifier and reinstall it to check whether the alarm is cleared. If the alarm still exists, replace the rectifier.
2. Remove the SMU and reinstall it to check whether the alarm is cleared. If the alarm still exists, replace the SMU.

7.2.11 Load Fuse Break

Possible Causes

- The load circuit breaker trips or fuse is blown.
- The load circuit breaker or fuse detection cable is disconnected.

Measures

1. Check whether the load circuit breaker trips or fuse is blown. If yes, rectify the back-end circuit fault and then switch on the circuit breaker or replace the fuse.
2. Check whether the load circuit breaker or fuse detection cable is disconnected. If yes, reconnect the cable.

7.2.12 Batt Loop Trip

Possible Causes

- The battery circuit breaker trips or battery fuse detection cable is disconnected.
- The battery circuit breaker trips or battery fuse is blown.

- The contactor is faulty.

Measures

1. Check whether the battery circuit breaker trips or battery fuse detection cable is disconnected. If yes, reconnect the cable.
2. Check whether the battery circuit breaker trips or battery fuse is blown. If yes, rectify the battery loop fault and then switch on the circuit breaker or replace the fuse.
3. Manually switch on or switch off the battery contactor and check the battery current changes accordingly. If no, replace the contactor.

7.2.13 Batt Off

Possible Causes

- An AC power failure occurs.
- Batteries are manually disconnected.
- The battery disconnection voltage is set too high on the SMU.
- Rectifiers are faulty.
- The system configuration is not proper.

Measures

1. Check whether an AC power failure occurs. If yes, resume the AC power supply.
2. Check whether batteries are manually disconnected. If yes, confirm the reason of the manual disconnection, and reconnect the batteries after the operation.
3. Check whether the battery disconnection voltage (43 V DC by default) is set too high on the SMU. If yes, adjust it to a proper value.
4. Check whether the power system capacity is insufficient for the loads due to rectifier failures. If yes, replace the faulty rectifier.
5. Check whether the load current is greater than the current power system capacity. If yes, expand the power system capacity or reduce the load power.

7.2.14 Door Alarm



NOTE

This alarm is generated only for the power system that has door status sensor installed.

Possible Causes

- The cabinet doors are open.
- The door status sensor is faulty.

Measures

1. Close cabinet doors.
2. Check whether the door status sensor is faulty. If yes, replace the door status sensor.

7.2.15 Water Alarm



NOTE

This alarm is generated only for the power system that has water sensors installed.

Possible Causes

- Water intrudes into the cabinet.
- The water sensor is faulty.

Measures

1. Check whether water intrudes into the cabinet. If yes, wipe the water with dry cotton or other tools and rectify the fault.
2. Check whether the water sensor is faulty. If yes, replace the water sensor.

7.2.16 Smoke Alarm



NOTE

This alarm is generated only for the power system that has smoke sensors installed.

Possible Causes

- There is smoke inside the cabinet.
- The smoke sensor is faulty.

Measures

1. Check whether there is smoke inside the cabinet. If yes, disconnect the power supply from the cabinet, handle the fault, and then resume system operation and clear the alarm on the SMU.
2. Check whether the smoke sensor is faulty. If yes, replace the smoke sensor.

7.2.17 Rect Fault

Possible Causes

- The rectifier is in poor contact.
- The rectifier is faulty.

Measures

1. Check the Fault indicator on the rectifier panel. If it is steady red, remove the rectifier, and then reinstall it after the indicator turns off.
2. If the alarm still exists, replace the rectifier.

7.2.18 Rect Protection

Possible Causes

- The rectifier input voltage is too high.
- The rectifier input voltage is too low.

- The ambient temperature is too high.
- The rectifier is abnormal.

Measures

1. Check whether the AC input voltage exceeds the upper threshold of the rectifier working voltage. If yes, rectify the power supply fault and then resume the power supply.
2. Check whether the AC input voltage is below the lower threshold of the rectifier working voltage. If yes, rectify the power supply fault and then resume the power supply.
3. Check whether the ambient temperature is higher than the normal operating temperature of the rectifier. If yes, check and rectify the temperature unit fault.
4. Remove the rectifier that generates the alarm and reinstall it after the indicator turns off. If the alarm still exists, replace the rectifier.

7.2.19 Single Rect Fault

Possible Causes

- The subrack or slot connector is faulty.
- The rectifier is faulty.
- The monitoring unit is faulty.

Measures

1. Remove the rectifier and check whether the slot connector is damaged or deformed. If yes, repair or replace the subrack or slot connector.
2. If the alarm persists after the rectifier is reinstalled, replace the rectifier.
3. If the alarm persists after the monitoring unit is restarted, replace the monitoring unit.

7.2.20 Multi-Rect. Fault

Possible Causes

- The subrack or slot connectors are faulty.
- The rectifiers are faulty.
- The monitoring unit is faulty.

Measures

1. Remove the rectifiers and check whether the slot connectors are damaged or deformed. If yes, repair or replace the subrack or slot connectors.
2. If the alarm persists after the rectifiers are reinstalled, replace the rectifiers.
3. If the alarm persists after the monitoring unit is restarted, replace the monitoring unit.

7.2.21 Rect Comm Fault

Possible Causes

- The rectifier is removed.
- The rectifier is in poor contact.

- The rectifier is faulty.

Measures

1. Check whether the rectifier is removed. If yes, reinstall it.
2. If the rectifier is in position, remove the rectifier and reinstall it.
3. If the alarm still exists, replace the rectifier.

7.3 Identifying Faults

7.3.1 Identifying Rectifier Faults

Table 7-2 Identifying rectifier faults

Symptom	Possible Cause	Measures
The Run indicator (green) is off.	There is no AC input, or the rectifier is faulty.	Check whether the AC input is normal. If the AC input is normal, replace the rectifier. If the AC input is normal and the green indicators on all rectifiers are off, replace the AC/DC power distribution subrack.
The Run indicator (green) is blinking (0.5 Hz).	The rectifier is being queried manually.	Exit the query status. The Run indicator recovers to be steady on.
The Run indicator (green) is blinking (4 Hz).	Software is being loaded.	After software loading is complete, the indicator stops blinking.
The Alarm indicator (yellow) is steady on.	<ul style="list-style-type: none"> • The rectifier protects against overtemperature. • The rectifier protects against AC input overvoltage or undervoltage. • The rectifier is faulty. 	<ul style="list-style-type: none"> • If the ambient temperature is higher than the upper threshold, lower the ambient temperature. • If the air intake vent or the air exhaust vent is blocked, unblock it. • If the AC input is abnormal, ask mains maintenance personnel to rectify the fault. • If the fault persists, the rectifier may be faulty. In this case, replace the faulty rectifier.
The Alarm indicator (yellow) is blinking.	Communication between the rectifier and the SMU is	Clean the edge connector of the faulty rectifier. If the Alarm indicator is still

Symptom	Possible Cause	Measures
	interrupted.	blinking, check the SMU and the AC/DC power distribution subrack.
The Fault indicator (red) is steady on.	The rectifier protects against output overvoltage.	<ul style="list-style-type: none"> If a single rectifier is locked, remove the rectifier whose indicator is steady red, and then power on the rectifier after the indicator turns off. If the overvoltage still occurs, replace the rectifier. If multiple rectifiers are locked, remove all rectifiers and reinstall them one by one to locate the faulty rectifiers. Then replace faulty rectifiers.
	The rectifier has no output due to an internal fault.	Replace the faulty rectifier.

7.3.2 Identifying SMU Faults

Table 7-3 Identifying SMU faults

Symptom	Cause	Measures
The Run indicator (green) is off.	There is no input.	<ul style="list-style-type: none"> Check whether the green indicators on rectifiers are steady on. If yes, the input to the ETP48150-A3 is normal. Reseat the SMU. If the fault persists, replace the SMU.
The Run indicator (green) is blinking fast.	The SMU fails to communicate with the host.	Check whether the communication between the SMU and the host is normal.
The Alarm indicator (red) is steady on.	A major or critical alarm is generated.	Query the current alarm on the host or SMU LCD to identify the fault.

7.3.3 Identifying PDU Faults

Table 7-4 Identifying PDU faults

Symptom	Cause	Measures
Load disconnection	The positive and negative cables of the load are reversely connected.	Ensure that the positive and negative cables are properly connected.
Battery disconnection	The positive and negative cables of batteries are reversely connected.	Ensure that the positive and negative cables are properly connected.

7.4 Replacing Components



NOTICE

- Ensure that loads are supplied with power when replacing major components. For example, keep the switches for primary loads in the ON position, and do not turn off the battery switch and AC input switch at the same time.
 - Seek the customer's prior consent if load disconnection is required.
 - Do not maintain devices on raining days, preventing water from entering and damaging devices.
-

7.4.1 Replacing a Rectifier

Prerequisites

- You have obtained a pair of protective gloves and the cabinet door key.
- The new rectifier is intact.



CAUTION

Protect yourself from being burnt when moving the rectifier because the rectifier has a high temperature.

Procedure

Step 1 Put on protective gloves.

Step 2 Push the locking latch at the right side of the panel towards the left.

Step 3 Gently draw the handle outwards, and then remove the rectifier from the subrack, as shown in [Figure 7-1](#).

Figure 7-1 Removing a rectifier

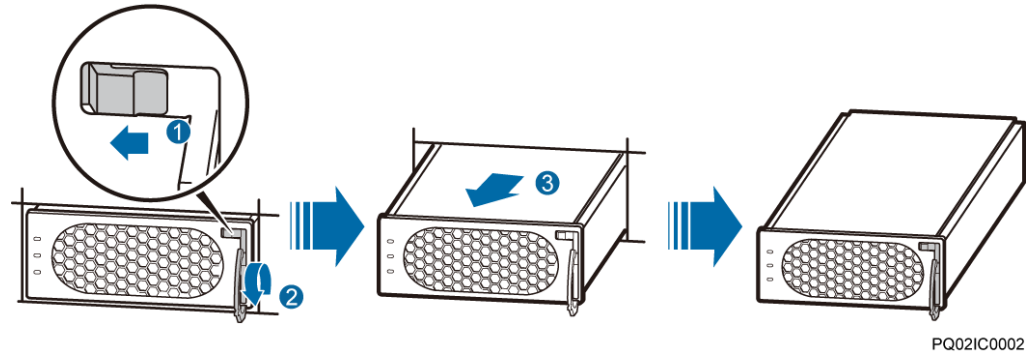

Step 4 Push the locking latch on the new rectifier towards the left, and pull out the handle.

Step 5 Place the new rectifier at the entry to the correct slot.

Step 6 Gently slide the converter into the slot along guide rails until it is engaged. Close the handle, and push the locking latch towards the right to lock the handle, as shown in [Figure 7-2](#).

Figure 7-2 Installing a rectifier

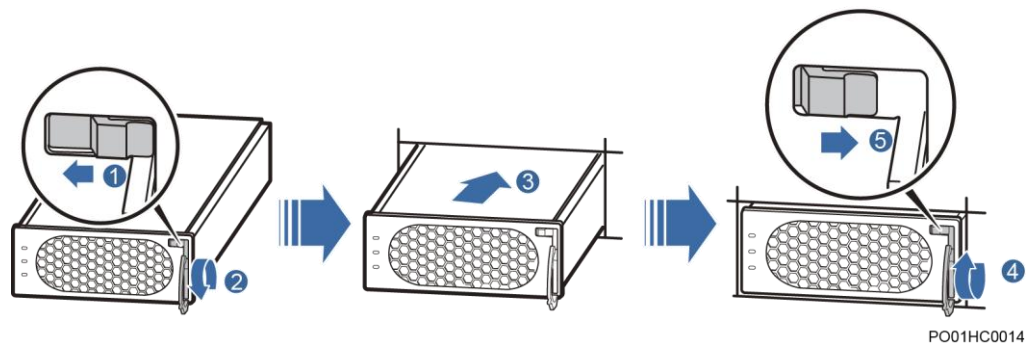

Step 7 Take off protective gloves.

----End

Follow-up Procedure

Pack the removed component, and return it to Huawei local warehouse.

7.4.2 Replacing an SMU

Prerequisites

- You have obtained an ESD wrist strap, a pair of protective gloves, an ESD box or bag.
- The new rectifier is intact.

Procedure

- Step 1** Push the locking latch towards the left.
- Step 2** Draw the handle outwards to remove the SMU, as shown in [Figure 7-3](#).

Figure 7-3 Removing an SMU

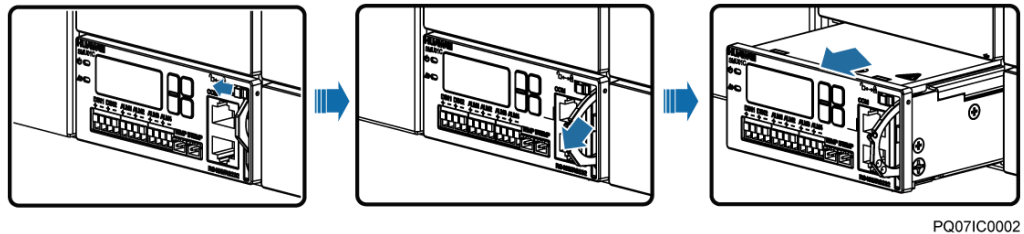

- Step 3** Insert a new SMU into the slot, push the locking latch towards the left, and pull out the handle.
- Step 4** Slide the SMU into the subrack slowly along the guide rail, push in the handle, and then push the locking latch towards the right.
- Step 5** Reset SMU parameters.

Figure 7-4 Installing an SMU

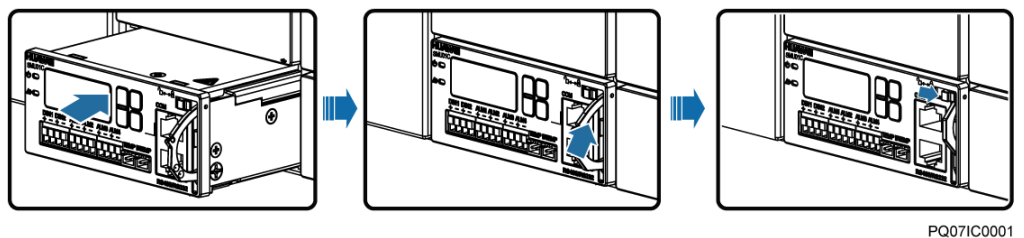

----End

Follow-up Procedure

Pack the removed component and have it sent to the local Huawei warehouse.

7.4.3 Replacing a Battery String

Procedure

- Step 1** Ensure that the AC input power supply is normal.
- Step 2** Switch off the battery circuit breaker.
- Step 3** Replace batteries. Ensure that the positive and negative battery cables are properly connected.
- Step 4** Switch on the battery circuit breaker.

Step 5 Wait until the system is powered on automatically. Check that the battery status is normal (that is, no battery loop broken alarm is generated and the battery charging current is not 0.).

----End

A Appendix

A.1 Technical Specifications

Table A-1 Technical Specifications

Category	Item	Specifications
Environmental conditions	Operating temperature	-40 ℃ to +70 ℃ NOTE The system can run for 8 hours at 70 ℃.
	Transportation temperature	-40 ℃ to +70 ℃
	Storage temperature	-40 ℃ to +70 ℃
	Operating humidity	5%–95% RH (non-condensing)
	Storage humidity	5%–95% RH (non-condensing)
	Altitude	0-4000 m When the altitude ranges from 2000 m to 4000 m, the operating temperature decreases by 1 ℃ for each additional 200 m.
AC input	Input mode	230 V AC single-phase three-wire (L, N), compatible with 230 V AC dual-live-wire (L, L)
	Input frequency	45–66 Hz (rated frequency: 50/60 Hz)
	Power factor	≥ 0.99 (100% load)
DC output	Output voltage range	-42 V DC- -58 V DC
	Default output voltage	-53.5 V DC
	Maximum output power	2000 W
	Regulated voltage precision	≤ ±0.6%

Category	Item	Specifications
	Peak-to-peak noise voltage	≤ 200 mV (0–20 MHz)
AC input protection	AC input overvoltage protection threshold	Overvoltage protection is performed when the single-phase AC input voltage exceeds the AC input overvoltage protection threshold (300 V AC by default).
	AC input overvoltage recovery threshold	When the voltage is restored to 290 V AC, the output resumes.
	AC input undervoltage protection threshold	Undervoltage protection is performed when the single-phase AC input voltage is below the AC input undervoltage protection threshold (80 V AC by default).
	AC input undervoltage recovery threshold	When the voltage is restored to 85 V AC, the output resumes.
DC output protection	DC output overvoltage protection threshold	-58.5 V DC to -60.5 V DC
Rectifier	Efficiency	<ul style="list-style-type: none"> R4815G1: Highest efficiency: $\geq 96\%$ $\geq 95\%$ (220 V AC, 40%-100% load) R4815N1: Highest efficiency: $\geq 94\%$ $\geq 93\%$ (220 V AC, 30%-100% load)
	Output Power	<ul style="list-style-type: none"> R4815G1: 870 W (input voltage range: 176-300 V AC) 435 W (input voltage range: 85-175 V AC, linearly derated) R4815N1: 1000 W (input voltage range: 176-300 V AC) 470 W (input voltage range: 85-175 V AC, linearly derated)
	Output soft start	At the moment when the rectifier is powered on, the output voltage rises slowly.
	Overvoltage protection	-58.5 V DC to -60.5 V DC <ol style="list-style-type: none"> If the overvoltage occurs inside the rectifier due to a fault, the rectifier experiences a latch-off. If the output voltage is higher than -63 V DC and lasts for more than 500 ms, the rectifier experiences a latch-off.
EMC	Conducted Emission (CE)	Input port: CISPR 22/EN 55022 class B
		Output port: CISPR 22/EN 55022 class A
	Radiated emission (RE)	CISPR 22/EN 55022 class B
	Harmonic	IEC 61000-3-2

Category	Item	Specifications
	Fluctuation and blinking	IEC 61000-3-3
	ESD	Enclosure port: Contact discharge voltage: 6 kV (Class B); air discharge voltage: 8 kV (Class B); Signal port: Contact discharge voltage: 2 kV (Class R)
	Electrical fast transient (EFT)	The voltage at signal ports is 1 kV, and the voltage at the power ports is 2 kV (criterion B).
	Radiated susceptibility (RS)	Level 3; criterion: A; field strength: 10 V/m
	Conducted susceptibility (CS)	Signal port: 3 V (criterion A); power port: 10 V
	SURGE	<ul style="list-style-type: none"> (For the AC power port) differential mode: ± 2 kV; common mode: ± 4 kV (criterion B) (For the DC power port) differential mode: ± 2 kV/2 ohms; common mode: ± 2 kV/12 ohms, ± 4 kV/12 ohms (+48 V and PE are short-circuited); isolation protection enabled, criterion B (For internal signal cables) differential mode: ± 0.5 kV; common mode: ± 1 kV; waveform: 8/20(1.2/50) μs, criterion B (For external signal cables) differential mode: ± 2 kV; common mode: ± 4 kV; waveform: 8/20(1.2/50) μs, criterion B
	DIP	EN61000-4-11
Others	Safety and regulatory design	Complies with IEC/EN60950-1/GB 4943 and passes TUV and CE.
	Mean time between failures (MTBF)	250,000 hours
Structure	Dimensions (H x W x D)	43.6 mm x 442 mm x 255 mm
	Weight	≤ 10 kg (with rectifiers)
	Protection level	IP20
	Installation mode	Adapts to 19-inch cabinets and ETSI cabinets by using different types of mounting ears
	Maintenance mode	Maintained from the front

A.2 Electrical Conceptual Diagram

Figure A-1 ETP4830-A1 electrical conceptual diagram

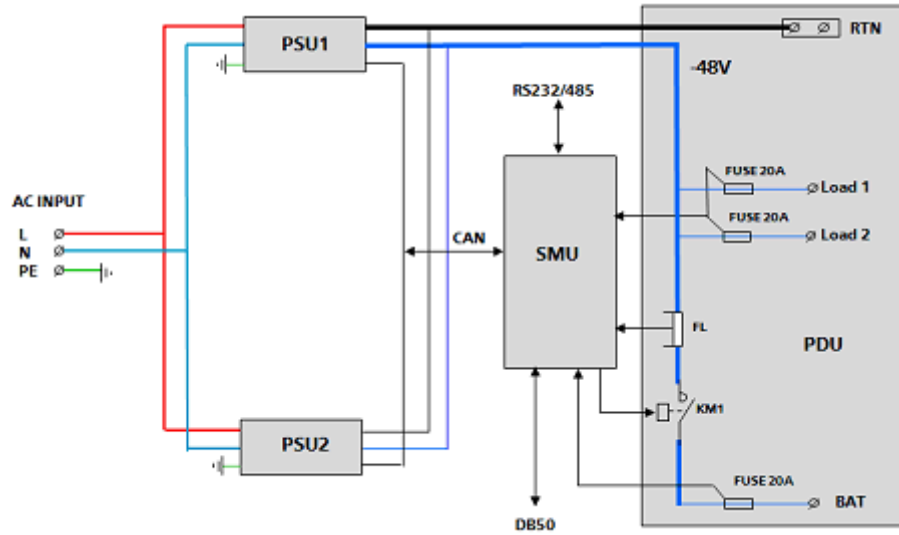

B Acronyms and Abbreviations

E

EMC electromagnetic compatibility

I

IEC International Electrotechnical Commission

IP Internet Protocol

L

LCD liquid crystal display

P

PDU Power Distribution Unit

PE protective earth

S

SMU site monitoring unit

T

TCP Transmission Control Protocol

U

USB Universal Serial Bus